



OWNER'S MANUAL

# DIGITAL A/V RECEIVER SYSTEM

Please read this manual carefully before operating your set and retain it for future reference.

## MODEL

AR805TS (AR805TS, SR85TS-F/S/C/W)

P/NO : MFL63267063

## 1

# Safety Information



**CAUTION:** TO REDUCE THE RISK OF ELECTRIC SHOCK DO NOT REMOVE COVER (OR BACK) NO USER-SERVICEABLE PARTS INSIDE REFER SERVICING TO QUALIFIED SERVICE PERSONNEL.



This lightning flash with arrowhead symbol within an equilateral triangle is intended to alert the user to the presence of uninsulated dangerous voltage within the product's enclosure that may be of sufficient magnitude to constitute a risk of electric shock to persons.



The exclamation point within an equilateral triangle is intended to alert the user to the presence of important operating and maintenance (servicing) instructions in the literature accompanying the product.

## Cautions and Warnings

**WARNING:** TO PREVENT FIRE OR ELECTRIC SHOCK HAZARD, DO NOT EXPOSE THIS PRODUCT TO RAIN OR MOISTURE.

**WARNING:** Do not install this equipment in a confined space such as a book case or similar unit.

**CAUTION:** The apparatus shall not be exposed to water (dripping or splashing) and no objects filled with liquids, such as vases, shall be placed on the apparatus.

**CAUTION:** Do not block any ventilation openings. Install in accordance with the manufacturer's instructions.

Slots and openings in the cabinet are provided for ventilation and to ensure reliable operation of the product and to protect it from over heating. The openings shall be never be blocked by placing the product on a bed, sofa, rug or other similar surface. This product shall not be placed in a built-in installation such as a bookcase or rack unless proper ventilation is provided or the manufacturer's instruction has been adhered to.

### **CAUTION concerning the Power Cord**

Most appliances recommend they be placed upon a dedicated circuit;

That is, a single outlet circuit which powers only that appliance and has no additional outlets or branch circuits. Check the specification page of this owner's manual to be certain. Do not overload wall outlets. Overloaded wall outlets, loose or damaged wall outlets, extension cords, frayed power cords, or damaged or cracked wire insulation are dangerous. Any of these conditions could result in electric shock or fire. Periodically examine the cord of your appliance, and if its appearance indicates damage or deterioration, unplug it, discontinue use of the appliance, and have the cord replaced with an exact replacement part by an authorized service centre. Protect the power cord from physical or mechanical abuse, such as being twisted, kinked, pinched, closed in a door, or walked upon. Pay particular attention to plugs, wall outlets, and the point where the cord exits the appliance. To disconnect power from the mains, pull out the mains cord plug. When installing the product, ensure that the plug is easily accessible.

This device is equipped with a portable battery or accumulator.

**Safety way to remove the battery or the battery from the equipment:**

Remove the old battery or battery pack, follow the steps in reverse order than the assembly. To prevent contamination of the environment and bring on possible threat to human and animal health, the old battery or the battery put it in the appropriate container at designated collection points. Do not dispose of batteries or battery together with other waste. It is recommended that you use local, free reimbursement systems batteries and accumulators. The battery shall not be exposed to excessive heat such as sunshine, fire or the like.

## Copyrights

It is forbidden by law to copy, broadcast, show, broadcast via cable, play in public, or rent copyrighted material without permission. This product features the copy protection function developed by Macrovision. Copy protection signals are recorded on some discs. When recording and playing the pictures of these discs picture noise will appear. This product incorporates copyright protection technology that is protected by U.S. patents and other intellectual property rights. Use of this copyright protection technology must be authorized by Macrovision, and is intended for home and other limited viewing uses only unless otherwise authorized by Macrovision. Reverse engineering or disassembly is prohibited.

CONSUMERS SHOULD NOTE THAT NOT ALL HIGH DEFINITION TELEVISION SETS ARE FULLY COMPATIBLE WITH THIS PRODUCT AND MAY CAUSE ARTIFACTS TO BE DISPLAYED IN THE PICTURE. IN CASE OF 525 OR 625 PROGRESSIVE SCAN PICTURE PROBLEMS, IT IS RECOMMENDED THAT THE USER SWITCH THE CONNECTION TO THE 'STANDARD DEFINITION' OUTPUT. IF THERE ARE QUESTIONS REGARDING OUR TV SET COMPATIBILITY WITH THIS MODEL 525p AND 625p UNIT, PLEASE CONTACT OUR CUSTOMER SERVICE CENTER.

You have to set the disc format option to [Mastered] in order to make the discs compatible with the LG players when formatting rewritable discs. When setting the option to Live File System, you cannot use it on LG players.

(Mastered/ Live File System : Disc format system for Windows Vista)

# Contents

## 1

### Safety Information

---

- 2 Cautions and Warnings
- 3 Copyrights

## 2

### Preparation

---

- 6 Introduction
  - 6 About the "⓪" Symbol Display
  - 6 Symbols Used in this Manual
  - 6 Accessories
  - 7 Required cables
- 8 Remote control
- 10 Front panel
- 11 Rear panel

## 3

### Installation

---

- 12 Installing speakers
- 13 Connecting speakers
- 14 Connecting to Your TV
  - 14 Video/Audio (Left/Right) connection
  - 15 HDMI connection
  - 16 Resolution Setting
- 16 Connecting TV or components with HDMI jack
- 17 Connecting components with analog video and audio jacks
  - 17 AV IN 1 connection
  - 17 AV IN 2 connection
- 18 Connecting components with Digital Audio jacks
  - 18 Optical digital audio connection
  - 18 Coaxial digital audio connection
- 19 Connecting the portable device
- 19 Connecting the antennas
- 20 Connecting the headphones
- 21 Settings
  - 21 Adjusting the Setup Settings
  - 21 [Language] Menu
  - 21 [Display] Menu
  - 22 [Audio] Menu
  - 23 [Others] Menu

## 4 Operation

---

- 24 Turning On the unit
- 24 Selecting the input source
- 25 Adjusting the speaker levels
- 26 Enjoying various sound mode
  - 26 Sound Effect
  - 27 Bass Blast
  - 27 Setting the USER EQ
- 27 Listening to FM/AM radio
  - 27 Automatic tuning
  - 27 Manual tuning
  - 28 Presetting radio stations
  - 28 Tuning to preset stations
  - 28 Deleting the preset stations
  - 28 Deleting all the preset stations
- 29 Playing the USB device
  - 29 Basic operations
  - 31 Listening to music
  - 32 Playing a movie file
  - 34 Viewing a photo
- 35 Dimmer
- 35 Screen Saver
- 36 Using the Sleep Timer
- 36 Using microphone

## 5 Maintenance

---

- 37 Handling the Unit

## 6 Troubleshooting

---

- 38 Troubleshooting

## 7 Appendix

---

- 40 Trademarks and Licenses
- 41 Specifications

1

2

3

4

5

6

7

# 2 Preparation

## Introduction

### About the “Ø” Symbol Display

“Ø” may appear on your TV display during operation and indicates that the function explained in this owner’s manual is not available on that specific media.

### Symbols Used in this Manual



#### NOTE

Indicates special notes and operating features.



#### CAUTION

Indicates cautions for preventing possible damages from abuse.

A section whose title has one of the following symbols are applicable only to the disc represented by the symbol.

#### MOVIE

Movie files contained in the USB

#### MUSIC

Music files contained in the USB

#### PHOTO

Photo files contained in the USB

### Accessories

Please check and identify the supplied accessories.

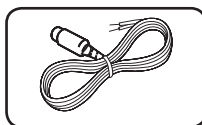

FM antenna (1)

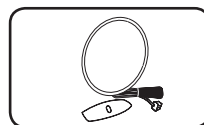

AM antenna (1)

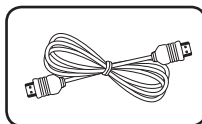

HDMI cable (1)

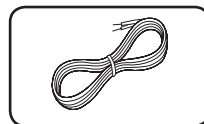

Speaker cables (5)

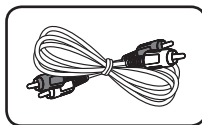

Analog audio cable (1)

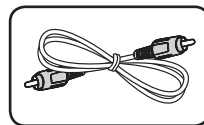

Composite video cable (1)

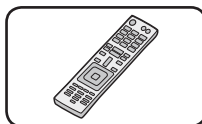

Remote control (1)

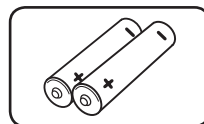

Batteries (2)

## Required cables

The hookup diagrams on the subsequent pages assume the use of the following connection cables.

You must purchase the connection cables separately if necessary.

- Analog audio cable



- Composite video cable



- Analog audio/Composite video cable

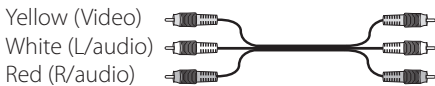

- Optical digital audio cable



- Coaxial digital audio cable



- USB cable



- HDMI cable



- Portable cable



### ! NOTE

- Turn off the power to all components before making any connections.
- When connecting an audio/video cable, be sure to match the colour-coded pins to the appropriate jacks on the components: yellow (video) to yellow; white (left, audio) to white; and red (right, audio) to red.
- When connecting optical digital cables, insert the cable plugs straight in until they click into place.
- Do not bend or tie optical digital cables.

## Remote control

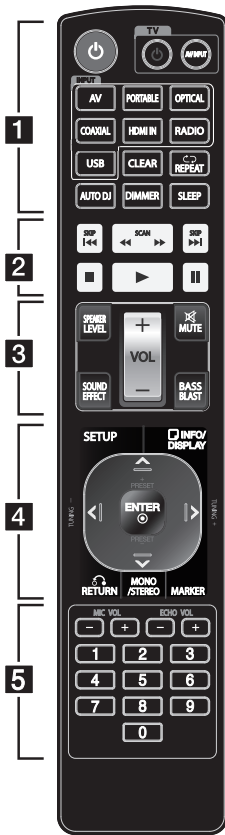

### Battery Installation

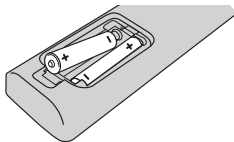

Remove the battery cover on the rear of the Remote Control, and insert two R03 (size AAA) batteries with **+** and **-** matched correctly.

• • • • • **1** • • • • •

**POWER** (⏻): Switches the unit ON or OFF.

**TV control buttons:** Controls the TV. (LG TV only)

- ⏻ : Turns the TV on or off.
- AV/INPUT : Switches the TV's input source between the TV and other input sources.

**INPUT buttons:** Selects the input source you want to use. (Page 25)

- AV: Selects the input source connected to AV IN 1/2 jack.
- PORTABLE: Selects the input source connected to PORT. IN jack.
- OPTICAL: Selects the input source connected to OPTICAL IN 1/2 jack.
- COAXIAL: Selects the input source connected to COAXIAL IN 1/2 jack.
- HDMI IN: Selects the input source connected to HDMI IN jack.
- RADIO: Selects the FM/AM.
- USB: Selects the input source connected to USB port.

**CLEAR:** Deletes a preset stations. (Page 28)

↺ **REPEAT:** Selects a play mode. (Repeat playback/ Random playback) (Page 32)

**AUTO DJ:** Selects the AUTO DJ mode. (Page 32)

**DIMMER:** The display window is darkened by half. (Page 35)

**SLEEP:** Sets the system to turn off automatically at a specified time. (Page 36)



## 2

**⏪/⏩ (SKIP):** Goes to the next or previous chapter / track / file.

**⏮/⏭ (SCAN):** Searches backward or forward.

**■ (STOP):** Stops playback.

**▶ (PLAY):** Starts playback.

**⏸ (PAUSE):** Pauses playback.

## 3

**SPEAKER LEVEL:** Sets the sound level of desired speaker. (Page 25)

**SOUND EFFECT:** Selects a sound effect mode. (Page 26)

**VOL (-/+):** Adjusts speaker volume.

**MUTE (⏶):** Turns off the sound temporarily. Press the button again to restore the sound.

**BASS BLAST:** Selects the BASS BLAST sound mode directly. (Page 27)

## 4

**SETUP:** Displays or exits the [SETUP] menu.

**RETURN (↩):** Moves backwards in the menu or exits the setup menu.

**INFO/DISPLAY (ℹ):** Displays or exits On-screen Display. (Page 33, 35)

**ENTER (⊙):** Acknowledges menu selection.

**MARKER:** Marks music files on the [MUSIC] menu. (Page 31)

**PRESET (-/+):** Selects a preset stations.

**TUNING (-/+):** Tunes in the desired radio station.

**⤴/⤵/⤶/⤷ (up/ down/ left/ right):** Selects an option in the menu.

**MONO/STEREO:** Selects mono/stereo in FM mode. (Page 27)

## 5

**MIC VOL (-/+):** Adjusts the microphone volume. (Page 36)

**ECHO VOL (-/+):** Adjusts the echo volume. (Page 36)

**0 to 9 numerical buttons:** Selects numbered options in a menu.

## Front panel

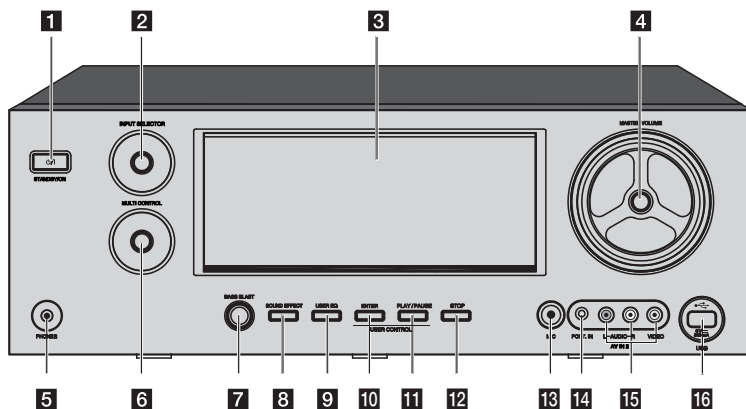

- 1 STANDBY/ON (⏻/⏻)**  
Switches the unit ON or OFF.
- 2 INPUT SELECTOR**  
Selects the input source. Rotate this knob until the input source you want appears in the display window.
- 3 Display window**  
Shows the current status of the unit.
- 4 MASTER VOLUME**  
Adjusts the speaker volume.
- 5 PHONES connector**  
Connects a stereo headphone plug (∅ 3.5 mm) to PHONES connector for private listening. (Page 20)
- 6 MULTI CONTROL**  
Adjusts the various options.
- 7 BASS BLAST**  
Selects the BASS BLAST sound mode directly. (Page 27)
- 8 SOUND EFFECT**  
Selects a sound effect mode. (Page 26)
- 9 USER EQ**  
Sets the USER EQ mode (BASS, MIDDLE and TREBLE). (Page 27)
- 10 ENTER**  
Acknowledges menu selection.
- 11 PLAY/PAUSE**  
Starts playback.  
Pauses playback, press it again to exit pause status.  
Moves to the BASS mode if you press PLAY/PAUSE on the front panel while the "USER EQ" is displayed in the display window.
- 12 STOP**  
Stops playback.
- 13 MIC**  
Connects a microphone (∅ 6.3 mm) to MIC jack.
- 14 PORT. IN**  
Connects a portable device (MP3 player, etc) to PORT. IN jack.
- 15 AV IN 2 (L-AUDIO-R, VIDEO)**  
Connects the components with analog audio/video output jacks (camcorder, video game, etc).
- 16 USB port (5 V --- 500 mA)**  
Connects an USB device to USB port.

## Rear panel

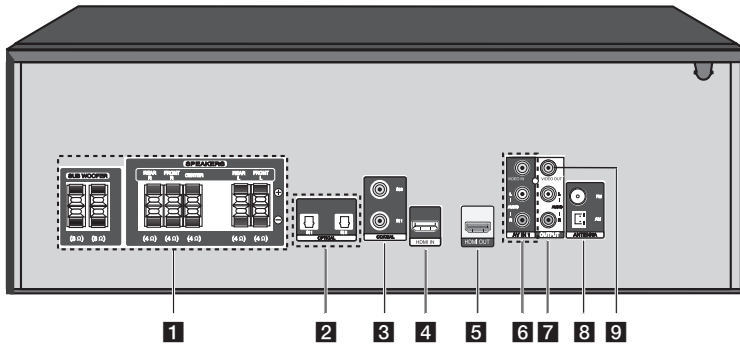

### 1 Speakers connectors

Connects the speaker cables.

### 2 OPTICAL IN 1/2

Connects other components with an optical digital audio output.

### 3 COAXIAL IN 1/2

Connects other components with a coaxial digital audio output.

### 4 HDMI IN

Connects the component with HDMI output.

### 5 HDMI OUT

Connects a TV or component with HDMI input.

### 6 AV IN 1 (L-AUDIO-R, VIDEO)

Connects the components with analog audio/video output jacks (DVD player, Blu-ray disc player, Satellite tuner, Set-top box, etc).

### 7 AUDIO L/R OUTPUT

Connects the components with analog audio input jacks.

### 8 Antenna connectors

FM – Connects the FM wired antenna.  
AM – Connects the AM loop antenna.

### 9 VIDEO OUT

Connects to your TV or projector with video input.

# 3 Installation

## Installing speakers

The unit allows you to use 5.2 channel system. The following illustration shows an example of positioning the system. Note that the illustrations in these instructions differ from the actual unit for explanation purposes. For the best possible rear sound, all the speakers other than the subwoofer should be placed at the same distance from the listening position (A).

Example of 5.2 channel speaker system configuration

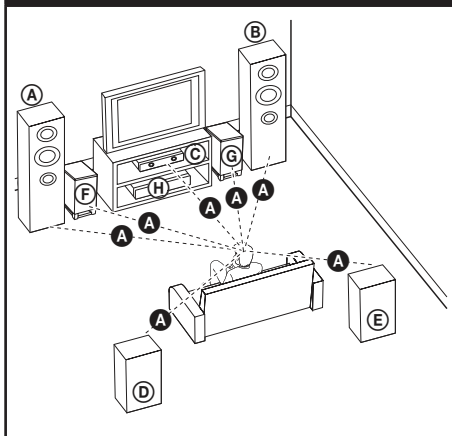

### (A) Front speaker (left)/ (B) Front speaker (right)

Place the front speakers to the sides of the monitor or screen and as flush with the screen surface as possible.

### (C) Center speaker

Place the center speaker above or below the monitor or screen.

### (D) Rear speaker (left)/ (E) Rear speaker (right)

Place these speakers behind your listening position, facing slightly inwards.

### (F)/(G) Subwoofer

The position of the subwoofer is not so critical, because low bass sounds are not highly directional. But it is better to place the subwoofer near the front speakers. Turn it slightly toward the center of the room to reduce the wall reflections.

### (H) Unit

#### ! CAUTION

- Be careful that the speaker should not fall down. Otherwise it may result in the speaker malfunctioning and causing personal injury and/or property damage.
- Make sure to install the speaker with other people in order to prevent it from falling and causing injuries to the installer.

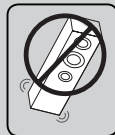

## Connecting speakers

Before connecting the cables, be sure to disconnect the AC power cord.

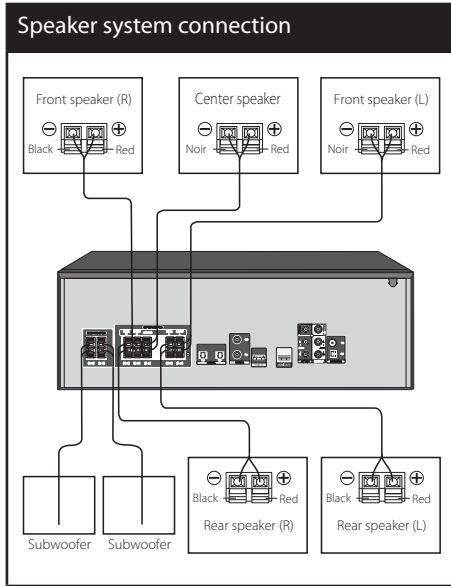

1. Connect the wires to the unit. To connect the cable to the unit, press each plastic finger pad to open the connection terminal. Insert the wire and release the finger pad.

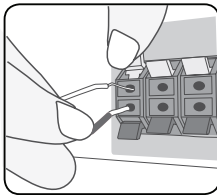

Connect the black end of each wire to the terminals marked - (minus) and the other end to the terminals marked + (plus).

2. Connect the wires to the speakers. Connect the other end of each wire to the correct speaker according to the color coding:

Color	Speaker	Position
Green	Center	Center
Orange	Subwoofer	Any front position
Red	Front	Front right
White	Front	Front left
Grey	Rear	Rear right
Blue	Rear	Rear left

To connect the cable to the speakers, press each plastic finger pad to open the connection terminals on the base of each speaker. Insert the wire and release the finger pad.

### CAUTION

- Be careful to make sure children not to put their hands or any objects into the \*speaker duct.
- \*Speaker duct: A hall for plentiful bass sound on speaker cabinet (enclosure).
- Place the centre speaker at a safe distance from the child's reach. Otherwise it may result in the speaker falling down and causing personal injury and/or property damage.
- The speakers contain magnet parts, so color irregularity may occur on the TV screen or PC monitor screen. Please use the speakers far away from either TV screen or PC monitor.

## Connecting to Your TV

You can watch the selected input image when you connect the VIDEO OUT or HDMI OUT jack to a TV.

It is not necessary to connect all the cables. Connect the cables according to the jacks of your components.

- Video/Audio (Left/Right) connection (page 14)
- HDMI connection (page 15)



### NOTE

- Before connecting the cables, be sure to disconnect the AC power cord.
- Turn off the power to all components before making any connections.
- When connecting an audio/video cable, be sure to match the colour-coded pins to the appropriate jacks on the components: yellow (video) to yellow; white (left, audio) to white; and red (right, audio) to red.

## Video/Audio (Left/Right) connection

Connect the VIDEO OUT jack on the unit to the video in jack on the TV using a video cable. Connect the left and right AUDIO OUT jacks of the unit to the audio left and right IN jacks on the TV using the audio cables.

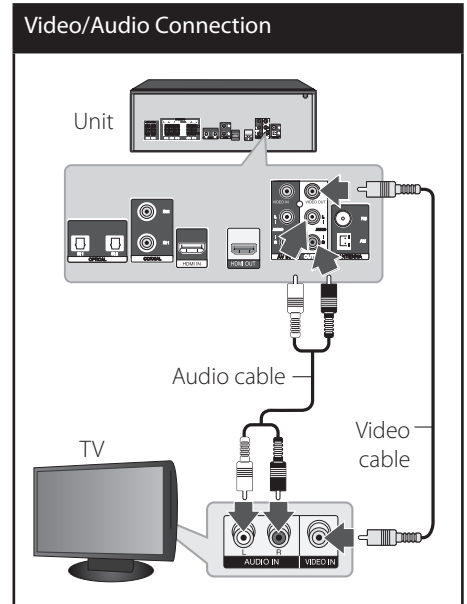

Set the TV's source to VIDEO (refer to TV's Owner's manual).

## HDMI connection

If you have a HDMI TV or monitor, you can connect it to this unit using a HDMI cable. Connect the HDMI OUT jack on the unit to the HDMI IN jack on a HDMI compatible TV or monitor.

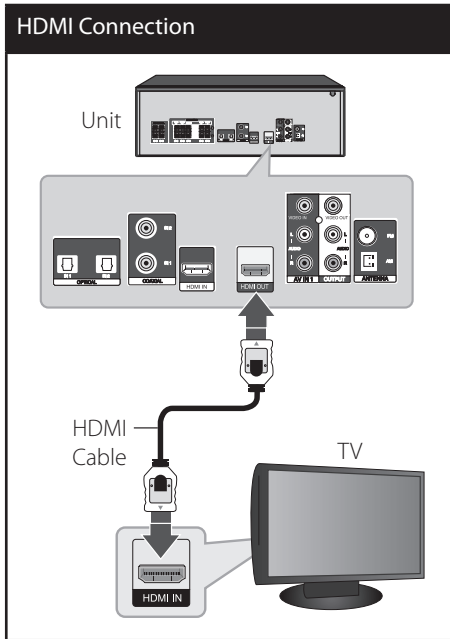

Set the TV's source to HDMI (refer to TV's Owner's manual).

### NOTE

- HDMI is the abbreviated name for High Definition Multimedia Interface. It is an interface which transmits video and audio signals in digital format. If a connected HDMI device does not accept the audio output of the unit, the HDMI device's audio sound may be distorted or may not output.
- When you use HDMI connection, you can change the resolution for the HDMI output. (Refer to "Resolution Setting" on page 16.)
- When you connect a HDMI or DVI compatible device make sure of the following:
  - Try switching off the HDMI/DVI device and this unit. Next, switch on the HDMI/DVI device and leave it for around 30 seconds, then switch on this unit.
  - The connected device's video input is set correctly for this unit.
  - The connected device is compatible with 720 x 480i (or 576i), 720 x 480p (or 576p), 1 280 x 720p, 1 920 x 1 080i or 1 920 x 1 080p video input.
- Not all HDCP-compatible HDMI or DVI devices will work with this unit.
  - The picture will not be displayed properly with non-HDCP device.
  - This unit does not playback and TV screen is changed to black screen.
- If there is noise or lines on the screen, please check the HDMI cable and use a higher version cable than 1.2A HDMI cable.
- Changing the resolution when the connection has already been established may result in malfunctions. To solve the problem, turn off the player and then turn it on again.
- When the HDMI connection with HDCP is not verified, TV screen is changed to black screen. In this case, check the HDMI connection, or disconnect the HDMI cable.

## Resolution Setting

The unit provides several output resolutions for HDMI OUT jack. You can change the resolution using [Setup] menu.

1. Press SETUP.  
The [Setup] menu appears.

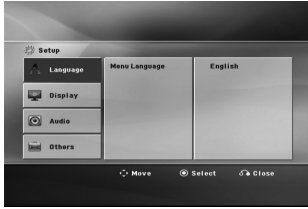

2. Use  $\Delta/\nabla$  to select [Display] option then press  $\rightarrow$  to move to the second level.

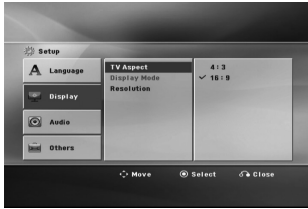

3. Use  $\Delta/\nabla$  to select the [Resolution] option then press  $\rightarrow$  to move to the third level.

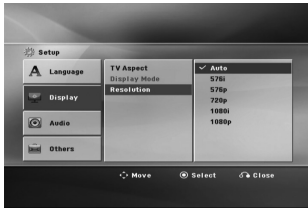

4. Use  $\Delta/\nabla$  to select the desired resolution then press ENTER (●) to confirm your selection.

### NOTE

If your TV does not accept the resolution you have set on the player, you can set resolution to 480p (or 576p) as follows:  
Press ■ (STOP) for more than 5 seconds.

## Connecting TV or components with HDMI jack

1. Connect the HDMI OUT jack on the unit to the HDMI IN jack on a HDMI compatible TV or monitor. Connect the HDMI IN jack on the unit to your components with HDMI OUT jack using a HDMI cable.

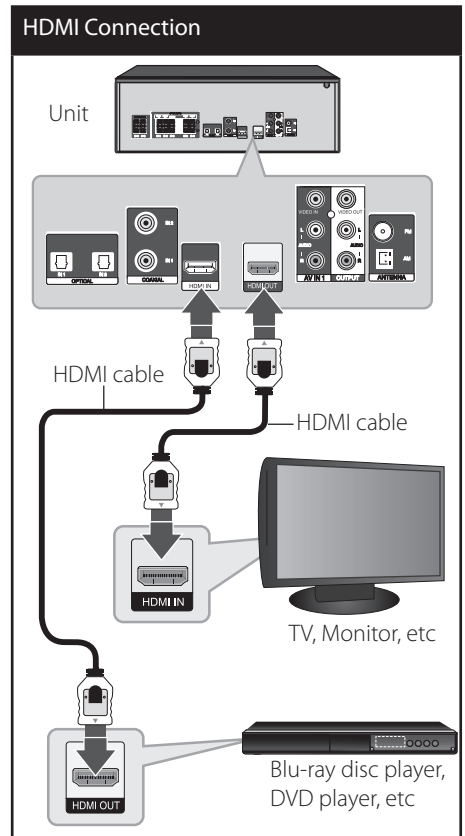

2. Set the input source to HDMI (Page 24).



# Connecting components with analog video and audio jacks

It is not necessary to connect all the cables. Connect the cables according to the jacks of your components. Before connecting the cables, be sure to disconnect the AC power cord.

## AV IN 1 connection

1. Connect the VIDEO IN jack on the unit to the VIDEO OUT jack on your component using a video cable. Connect the left and right AUDIO IN jacks of the unit to the audio left and right OUT jacks on your component using the audio cables.

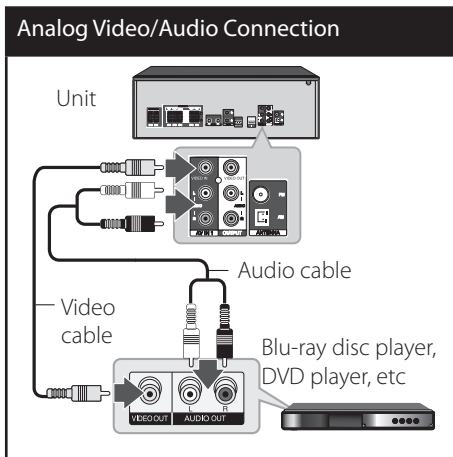

2. Connect the unit to your TV. Refer the "Video/Audio (Left/Right) connection" on the page 14.
3. Set the input source to AV 1 (Page 24).

## AV IN 2 connection

1. Connect the VIDEO IN jack on the unit to the VIDEO OUT jack on your component using a video cable. Connect the left and right AUDIO IN jacks of the unit to the audio left and right OUT jacks on your component using the audio cables.

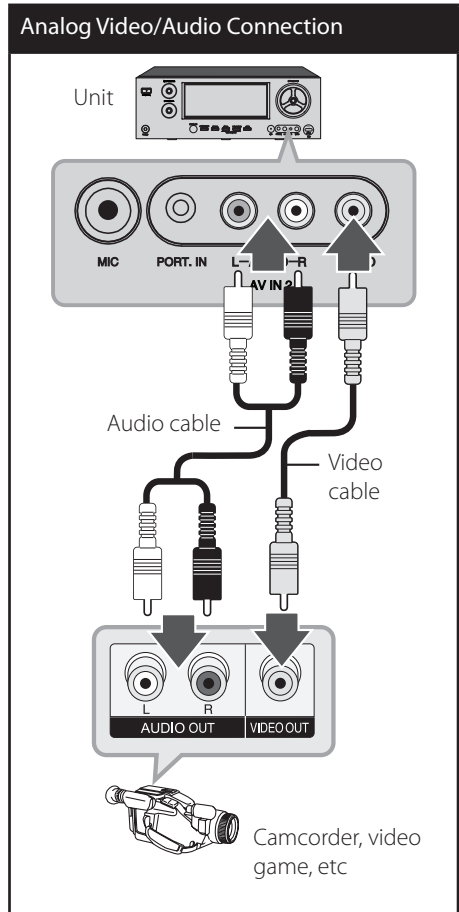

2. Connect the unit to your TV. Refer the "Video/Audio (Left/Right) connection" on the page 14.
3. Set the input source to AV 2 (Page 24).

## Connecting components with Digital Audio jacks

It is not necessary to connect all the cables. Connect the cables according to the jacks of your components. Before connecting the cables, be sure to disconnect the AC power cord.

### Optical digital audio connection

1. Connect the OPTICAL IN 1/2 jack on the unit to your components with OPTICAL OUT jack using an optical digital audio cable.

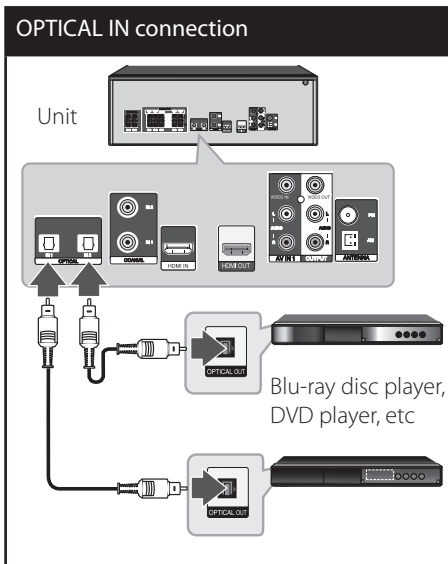

2. Set the input source to OPTICAL 1/ OPTICAL 2 (Page 24).

### Coaxial digital audio connection

1. Connect the COAXIAL IN 1/2 jack on the unit to your components with COAXIAL OUT jack using a coaxial digital audio cable.

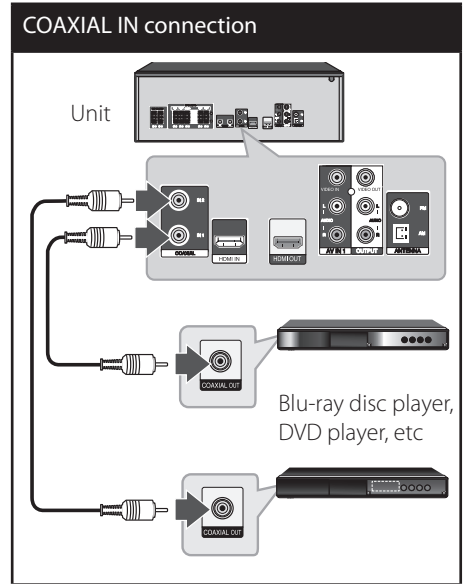

2. Set the input source to COAXIAL 1/ COAXIAL 2 (Page 24).

## Connecting the portable device

1. Connect the PORT. IN jack on the unit to the LINE OUT jack on your Portable device (MP3 player, etc...) using a portable cable ( $\phi$  3.5 mm).

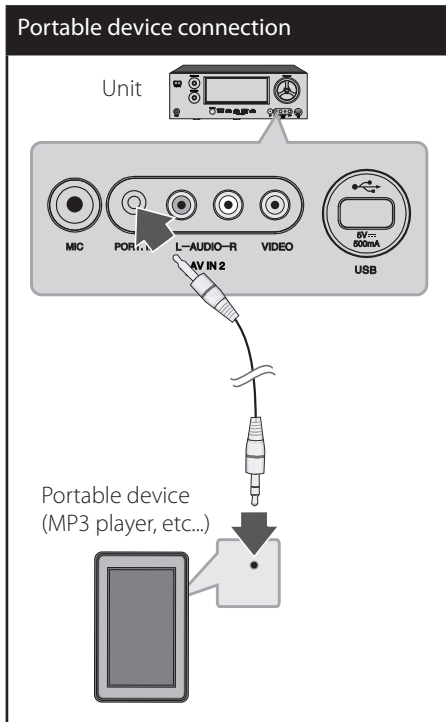

2. Set the input source to PORTABLE (Page 24).

## Connecting the antennas

Connect the supplied AM loop antenna and FM wire antenna.  
Before connecting the antenna, be sure to disconnect the AC power cord.

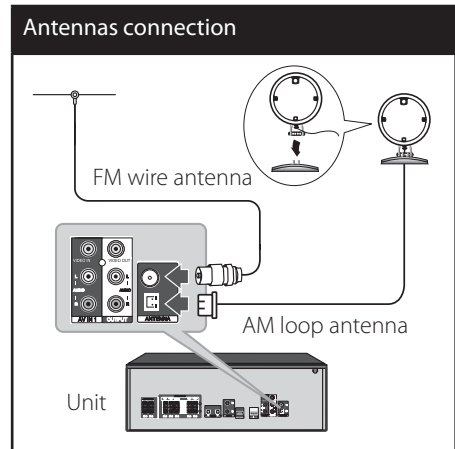

### NOTE

- To prevent noise pickup, keep the AM Loop antenna away from the unit and other components.
- Be sure to fully extend the FM wire antenna.
- After connecting the FM wire antenna, keep it as horizontal as possible.

## Connecting the headphones

Connect a pair of stereo headphones ( $\phi$  3.5 mm phone plug) to the unit's PHONES jack for private listening.

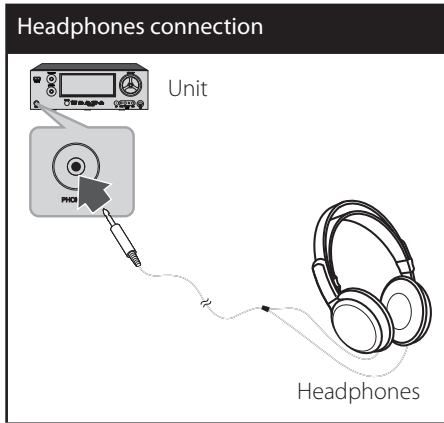

### ! NOTE

- Always turn down the volume before connecting your headphones.
- The speakers are turned off while the headphones plug is inserted in the PHONES jack.

# Settings

## Adjusting the Setup Settings

You can change the settings of the unit in the [Setup] menu.

1. Press **SETUP**.  
The [Setup] menu appears.



2. Use  $\wedge/\vee$  to select the first setup option, and press  $\>$  to move to the second level.



3. Use  $\wedge/\vee$  to select a second setup option, and press **ENTER** (Ⓞ) to move to the third level.

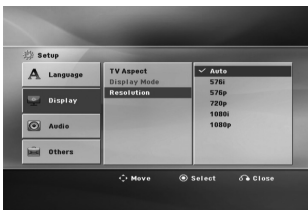

4. Use  $\wedge/\vee$  to select a desired setting, and press **ENTER** (Ⓞ) to confirm your selection.

## **A** [Language] Menu

### Menu Language

Select a language for the [Setup] menu and on-screen display.

## [Display] Menu

### TV Aspect

Select which screen aspect to use based on the shape of your TV screen.

#### [4:3]

Select when a standard 4:3 TV is connected.

#### [16:9]

Select when a 16:9 wide TV is connected.

### Display Mode

The Display Mode setting works only when the TV Aspect mode is set to 4:3.

#### [Letterbox]

Displays a wide picture with bands on the upper and lower portions of the screen.

#### [Panscan]

Automatically displays the wide picture on the entire screen and cuts off the portions that do not fit.

### Resolution

Sets the output resolution of the HDMI video signal. Refer to "Resolution Setting" for details about the resolution (page 16).

#### [Auto]

If the HDMI OUT jack is connected to TVs providing display information (EDID), automatically selects the resolution best suited to the connected TV.

**[576i]**

Outputs 576 lines of interlaced video.

**[576p]**

Outputs 576 lines of progressive video.

**[720p]**

Outputs 720 lines of progressive video.

**[1080i]**

Outputs 1080 lines of interlaced video.

**[1080p]**

Outputs 1080 lines of progressive video.

**[Audio] Menu****Speaker Setup**

Make the following settings for the built-in 5.2 channel surround decoder.

1. Select [Speaker Setup] on the [Audio] menu.
2. Press ENTER (⊙)  
The [SPEAKER] menu appears.



3. Use </> to select the desired speaker.
4. Adjust options using ^/V/</> buttons.
5. After adjusting the desired options, press RETURN (↵). The menu moves to the previous screen.

**[Speaker]**

Select a speaker that you want to adjust.

**NOTE**

Certain speaker settings are prohibited by the Dolby Digital licensing agreement.

**[Size]**

Since the speaker settings are fixed, you cannot change the settings.

**[Volume]**

Press </> to adjust the output level of the selected speaker.

- Front L/R : 0 ~ -5
- SubWoofer, Rear L/R, Center : 5 ~ -5

**[Distance]**

After you connected speakers to your unit, set the Distance between the speakers and your listening point if the distance of Center or Rear speakers is bigger than the distance of Front speakers. This allows the sound from each speaker to reach the listener at the same time. Press </> to adjust the Distance of the selected speaker. This distance is equivalent to a difference of the distance between Center or Rear speaker and Front speakers.

**[Speaker Test Start]/ [Speaker Test Stop]**

Select [Speaker Test Start] by using the ^/ V and press ENTER (⊙). Press ENTER (⊙) again to stop. Adjust the volume to match the volume of test signals memorized in the system.

## DRC (Dynamic Range Control)

When a title encoded in Dolby Digital or Dolby Digital Plus is playing back, you may wish to compress the dynamic range of the audio output (the difference between the loudest sounds and the quietest ones). This allows you to listen to a movie at a lower volume without losing clarity of sound. Set [DRC] to [On] for this effect.

## HD AV Sync

Sometimes Digital TV encounters a delay between picture and sound. If this happens you can compensate by setting a delay on the sound so that it effectively 'waits' for the picture to arrive: this is called HD AV Sync. Use **▲/▼** (on the remote control) to scroll up and down through the delay amount, which you can set at anything between 0 and 300m .



### NOTE

This function is only operated on the USB mode.



## [Others] Menu

### DivX(R) VOD

ABOUT DIVX VIDEO: DivX® is a digital video format created by DivX, Inc. This is an official DivX Certified device that plays DivX video. Visit [www.divx.com](http://www.divx.com) for more information and software tools to convert your files into DivX video.

ABOUT DIVX VIDEO-ON-DEMAND: This DivX Certified® device must be registered in order to play DivX Video-on-Demand (VOD) content. To generate the registration code, locate the DivX VOD section in the device setup menu. Go to [vod.divx.com](http://vod.divx.com) with this code to complete the registration process and learn more about DivX VOD.

---

#### [Register]

Displays the registration code of your unit.

---

#### [Deregister]

Deactivate your unit and display the deactivation code.

---



### NOTE

All the downloaded videos from DivX VOD with this player's registration code can only be played back on this unit.

# 4

## Operation

### Turning On the unit

Before connecting the power cord, connect all your speakers and AV components.

1. Plug the power cord into an AC wall outlet.
2. Press the POWER (⏻ or ⏻/⏻) button.  
The unit turns on, the display window lights up.

To turn off the unit, press the POWER (⏻ or ⏻/⏻) button.

### Selecting the input source

This section explains how to select the input source (i.e., the AV component that you want to listen to or watch).

1. Press POWER (⏻ or ⏻/⏻) to turn the unit on.
2. Select a source by rotating the INPUT SELECTOR on the front panel.  
The selected source appears in the display window.

To select the	Display
Component connected to AV IN 1 jack	AV 1
Component connected to AV IN 2 jack	AV 2
Portable device connected to PORT. IN jack	PORTABLE
Component connected to OPTICAL IN 1 jack	OPTICAL 1
Component connected to OPTICAL IN 2 jack	OPTICAL 2
Component connected to COAXIAL IN 1 jack	COAXIAL 1
Component connected to COAXIAL IN 2 jack	COAXIAL 2
Component connected to HDMI jack	HDMI IN
Built-in tuner	Tuner or frequency
USB device connected to USB port	USB



To select the required input source using the remote control, use the INPUT buttons.

To select the	Button
Component connected to AV IN 1/2 jack	AV
Portable device connected to PORT. IN jack	PORTABLE
Component connected to OPTICAL IN 1/2 jack	OPTICAL
Component connected to COAXIAL IN 1/2 jack	COAXIAL
Component connected to HDMI jack	HDMI IN
Built-in tuner	RADIO
USB device connected to USB port	USB

- Turn on the component and start playback.
- To adjust the volume, rotate the MASTER VOLUME on the front panel, or press VOL (-/+) on remote control.

### To activate the muting function

Press MUTE (⊗) on the remote control. To cancel, press MUTE (⊗) on the remote control again or rotate the MASTER VOLUME on the front panel.

## Adjusting the speaker levels

You can adjust the level of each speaker. These settings are applied to all sound fields. You can adjust from -5 to +5 in 1 step.

- Press SPEAKER LEVEL repeatedly to select a desired speaker to set.

The indicator changes cyclically in the display window as follows.

SW → FL → C → FR → RR → RL

- Press VOL (-/+) to adjust the sound level of the selected speaker while the indicator is displayed in the display window.

Display	Description
SW	Subwoofer (-5 to +5)
FL	Front speaker (left) (-5 to 0)
C	Center speaker (-5 to +5)
FR	Front speaker (right) (-5 to 0)
RR	Rear speaker (right) (-5 to +5)
RL	Rear speaker (left) (-5 to +5)

- Repeat and adjust the sound level of the other speakers.

## Enjoying various sound mode

You can enjoy various sound mode. For details, refer to the Sound Effect, Bass Blast, and USER EQ. (Pages 26-27)

### Sound Effect

You can select a suitable sound mode. Press SOUND EFFECT repeatedly until the desired mode appears in the display window.

Display	Description
NAT PLUS	You can enjoy the natural sound effect same as a 5.2-channel.
NATURAL	You can enjoy comfortable and natural sound.
Local specialization equalizer	Regionally optimized sound effect. (DANGDUT/ ARABIC/ PERSIAN/ INDIA/ REGUETON/ MERENGUE/ SAMBA/ SALSA/ CUMBIA/ AFRO)
AUTO EQ	Sets the sound equalizer to the mode that is the most similar to the genre which is included in the MP3 ID3 tag of song files.
POP CLASSIC JAZZ ROCK	This program lends an enthusiastic atmosphere to the sound, giving you the feeling you are at an actual rock pop, jazz or classic concert.
MP3-OPT	This function is optimized for compressible MP3 file. It improves the treble sound.

BASS BLAST	During playback, reinforces the bass sound.
LOUDNESS	Improves the bass and treble sound.
VIRTUAL	You can enjoy more virtual surround sound.
PL MOVIE PL MUSIC	Dolby Pro Logic II enables you to play stereo source on 5.2-channel.
BYPASS	You can enjoy the 2 channel sound from front speakers and subwoofer.

### NOTE

- In some of surround modes, some speakers, there's no sound or low sound. It depends on the mode of surround and the source of audio, it is not defective.
- You may need to reset the surround mode, after switching the input, sometimes even after the sound track changed.
- This function is not operated when the microphone is connected to the unit.

## Bass Blast

You can set the BASS BLAST sound mode directly.

Press BASS BLAST repeatedly.

Display	Description
BASS BLAST	During playback, reinforces the bass sound.
BYPASS	You can enjoy the 2 channel sound from front speakers and subwoofer.



### NOTE

This function is not operated when the microphone is connected to the unit.

## Setting the USER EQ

You can listen to music with desired sound effect by adjusting the BASS, MIDDLE and TREBLE.

1. Press USER EQ on the front panel. "USER EQ" appears in the display window.
2. Press PLAY/PAUSE on the front panel while the "USER EQ" is displayed in the display window.
3. Select the BASS, MIDDLE or TREBLE by pressing ENTER on the front panel.
4. Rotate MULTI CONTROL on the front panel to set sound level.
5. Press PLAY/PAUSE on the front panel to finish the settings.



### NOTE

This function is not operated when the microphone is connected to the unit.

## Listening to FM/AM radio

You can listen to FM and AM broadcasts through the built-in tuner. Before operation, make sure you have connected the FM and AM antennas to the unit. (Page 19)

### Automatic tuning

1. Rotate INPUT SELECTOR to select tuner (FM or AM). Or press RADIO with the remote control to select tuner (FM or AM).
2. Press TUNING - or TUNING + for more than 2 seconds.

Press TUNING - for more than 2 seconds to scan from high to low.

Press TUNING + for more than 2 seconds to scan from low to high.

The unit stops scanning whenever a station is received.

### In case of poor FM stereo reception

If the FM stereo reception is poor and "ST." flashes in the display window, select monaural audio so that the sound will be less distorted by pressing the MONO/STEREO.

The "ST." indicator disappears in the display window. There will be no stereo effect, but the reception will improve. Press the button again to restore the stereo effect.

### Manual tuning

Press TUNING - or TUNING + briefly and repeatedly on the FM or AM mode to select a station you want. Or rotate MULTI CONTROL on the unit.

## Presetting radio stations

You can preset up to 50 FM or AM stations. Then you can easily tune in the stations you often listen to.

1. Rotate INPUT SELECTOR to select tuner (FM or AM). Or press RADIO with the remote control to select tuner (FM or AM).
2. Tune in the station that you want to preset using Automatic tuning or Manual tuning.
3. Press ENTER (⊙).  
A preset number flashes in the display window for a few seconds. When a preset number flashes, do the step 4.
4. Press PRESET - or PRESET+ to select a preset number you want.  
If a preset number is not flashed before you select the preset number, start again from the step 3.
5. Press ENTER (⊙) again.  
The station is stored to the selected preset number. If a preset number is not flashed before you press ENTER (⊙), start again from the step 3.
6. Repeat the steps 2 to 5 to preset another station.

## Tuning to preset stations

Before tuning to preset stations, make sure you preset radio stations. (Page 28)

1. Rotate INPUT SELECTOR to select tuner (FM or AM). Or press RADIO with the remote control to select tuner (FM or AM).
2. Press PRESET - or PRESET+ repeatedly to select the preset station you want.  
Each time you press the button, you can select a preset station.

## Deleting the preset stations

You can delete a preset station you want.

1. Rotate INPUT SELECTOR to select tuner (FM or AM). Or press RADIO with the remote control to select tuner (FM or AM).
2. Select the preset station to delete by pressing PRESET - or PRESET+.
3. Press CLEAR.
4. Press CLEAR again while the preset number flashes in the display window for a few seconds.  
The preset station is deleted.
5. Repeat the steps 2 to 4 to delete another preset station.

## Deleting all the preset stations

1. Press and hold CLEAR for about two seconds.  
"ERASE ALL" appears in the display window.
2. Press CLEAR again while "ERASE ALL" is displayed.  
All the preset stations are cleared.

# Playing the USB device

This unit can play movie, music and photo files contained in the USB device.

## Basic operations

1. Insert an USB device to the USB port until it fits into place.

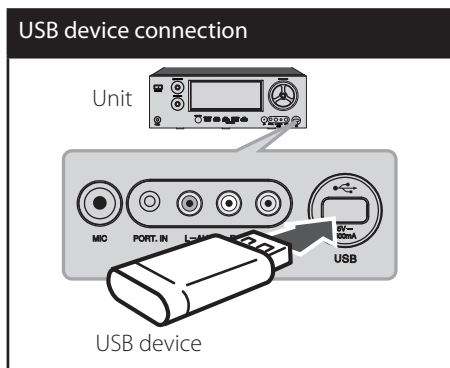

2. Rotate INPUT SELECTOR on the front panel to select until the "USB" appears in the display window. Or press USB on the remote control.

When you connect the USB device contained music files only in the USB device, the unit plays music files automatically. If the USB device is containing various types of files, the [USB] menu for the file type selection will appear.

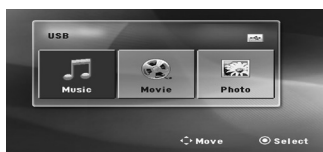

[USB] menu

3. Select [Music], [Movie] or [Photo] using </>, and press ENTER (⊙) to play the file.

### To stop playback

**MUSIC** **MOVIE** **PHOTO**

Press ■ (STOP) during playback.

### To pause playback

**MUSIC** **MOVIE**

Press ■■ (PAUSE) during playback.  
Press ▶ (PLAY) to resume playback.

### To scan forward or backward

**MUSIC** **MOVIE**

Press ◀◀ or ▶▶ to play fast forward or fast reverse during playback.  
You can change the various playback speeds by pressing ◀◀ or ▶▶ repeatedly.  
Press ▶ (PLAY) to return to normal speed.

### To skip to the next/previous chapter/track/file

**MUSIC** **MOVIE**

During playback, press ◀◀◀ or ▶▶▶ to go to the next chapter/track/file or to return to the beginning of the current chapter/track/file.  
Press ◀◀◀ twice briefly to step back to the previous chapter/track/file.

### PHOTO

During playback, press ◀◀◀ or ▶▶▶ to go to the previous/next file.

## To slow down the playing speed

### MOVIE

While the playback is paused, press ►► repeatedly to play various speeds of slow motion.

## Resume playback

### MUSIC MOVIE

The unit records the point where you pressed the ■ (STOP) depending on the file.

If "■■■ (Resume Stop)" appears on the screen briefly, press ► (PLAY) to resume playback (from the scene point).

If you press ■ (STOP) twice, "■ (Complete Stop)" appears on the screen. The unit will clear the stopped point.

## Removing the USB device from the unit

1. Choose a different function mode or press ■ (STOP) twice in a row.
2. Remove the USB device from the unit.

## Compatible USB Devices

- MP3 Player : Flash type MP3 player.
- USB Flash Drive : Devices that support USB 2.0 or USB 1.1.
- Some USB device may not work with this unit.

## NOTE

- Devices which require additional program installation connected to a computer, are not supported.
- Do not extract the USB device while in operation.
- For a large capacity USB, it may take longer than a few minute to be searched.
- Regular back up is recommended to prevent data loss.
- If you use a USB extension cable or USB hub, the USB device is not recognized.
- Using NTFS file system is not supported. (Only FAT(16/32) file system is supported.)
- This unit is not supported when the total number of files is 1 000 or more.
- External HDD, Card readers, Locked devices, or hard type usb devices are not supported.
- USB Port of the unit cannot be connected to PC. The unit cannot be used as a storage device.
- USB device: USB device that supports USB 1.1 and USB 2.0.
- Digital camera and mobile phone are not supported.

## Listening to music

You can play music files contained in a USB device.

1. Select [Music] using  $\leftarrow/\rightarrow$  on the [USB] menu.
2. Press ENTER (⊙).  
The unit plays music files automatically.

### Using the [MUSIC] menu

**[MUSIC] menu**



Options	Buttons	Description
UP FOLDER		Returning to the upper folder.
↓/↑	Select a desired option using $\wedge/\vee/\leftarrow/\rightarrow$ .	Moving to the previous or next page.
Select All		Marking all the files.
Deselect All		Deselecting all the marked files.
<input checked="" type="checkbox"/> Mark	MARKER	Marking the selected files.
◀▶▶▶	$\wedge/\vee/\leftarrow/\rightarrow$	Moving to another file.
⊙ Select	ENTER (⊙)	Activating a file.
↶ Close	RETURN (↶)	Returning to the [USB] menu.

**NOTE**

- The file requirements are described on page 32.
- You can use various playback functions. Refer to pages 29-30.

### Playing your favorite music

This enables you to play the marked music in order by marking your favorite files.

1. During playback, select your favorite files using  $\wedge/\vee$ .
2. Press MARKER.  
The  indicator appears on the [MUSIC] menu.
3. Repeat steps 1-2.
4. Press ▶ (PLAY) or ENTER (⊙).  
The play mode is displayed on the [MUSIC] menu.



5. Select the desired play mode using  $\wedge/\vee$ .  
[Mark Play]: Plays the marked files in order.  
[Current Play]: Plays the files in order from the highlighted position.
6. Press ENTER (⊙).

**NOTE**

- If you want to delete a marker, select the marked file and then press MARKER.
- The markers are also cleared when the USB device is removed, the unit is switched to power off or the function is switched to others.

### Playing repeatedly or randomly

During playback, press **↺↻** REPEAT repeatedly to select a desired mode.

Display	Description
REPEAT	The current file will be played repeatedly.
REPEAT ALL	All the files will be played repeatedly.
RANDOM	The files will be played in random order.
Off (No display)	Returns to normal playback.

### AUTO DJ playback

AUTO DJ blends the end of one song into the beginning of another for seamless playback.

During playback, press AUTO DJ repeatedly to select a desired mode.

Display	Description
AUTO DJ RANDOM	The music is played randomly on this mode.
AUTO DJ SEQUENTIAL	The music is played repeatedly on this mode.
AUTO DJ OFF	Returns to normal playback.

### Music file requirement

Music file compatibility with this unit is limited as follows :

- Sampling frequency : within 32 to 48 kHz (MP3), within 32 to 48 kHz (WMA)
- Bit rate : within 32 to 320 kbps (MP3), 40 to 192 kbps (WMA)
- Support Version : v2, v7, v8, v9
- Maximum files : Under 999
- File extensions : ".mp3"/".wma"
- CD-ROM file format : ISO 9660/ JOLIE T
- We recommend that you use Easy-CD Creator, which creates an ISO 9660 file system.

### Playing a movie file

You can play movie files contained in a USB device.

1. Select [Movie] using **</>** on the [USB] menu.
2. Select a file using **^/V</>**, and press **▶** (PLAY) or **ENTER** (**Ⓞ**) to play the file.

### Displaying content information on-screen

You can display and adjust various information and settings about the content.

1. During playback, press **INFO/DISPLAY** (**ℹ**) to show various playback information.

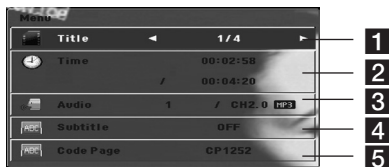



- 
- 1 Title** – current title number/total number of titles

---

  - 2 Time** – elapsed playing time/total playback time

---

  - 3 Audio** – selected audio language or channel

---

  - 4 Subtitle** – selected subtitle

---

  - 5 Code Page** – selected subtitle code page

2. Select an option using  $\wedge/V$ .
3. Use  $\langle / \rangle$  to adjust the selected option value.
4. Press INFO/DISPLAY (i) or RETURN (↵) to exit the On-Screen display.

### NOTE

If no button is pressed for a few seconds, the on-screen display disappears.

### Playing from selected time

1. Press INFO/DISPLAY (i) during playback. The time search box shows the elapsed playing time.
2. Select the [Time] option and then input the required start time in hours, minutes, and seconds from left to right.  
For example, to find a scene at 2 hours, 10 minutes, and 20 seconds, enter "21020".
3. Press ENTER (⊙) to start playback from selected time.

### Hearing different audio

1. During playback, press INFO/DISPLAY (i) to display the On-Screen display.
2. Use  $\wedge/V$  to select the [Audio] option.
3. Use  $\langle / \rangle$  to select desired audio language, audio track or audio channel.

### Selecting a subtitle language

1. During playback, press INFO/DISPLAY (i) to display the On-Screen display.
2. Use  $\wedge/V$  to select the [Subtitle] option.
3. Use  $\langle / \rangle$  to select desired subtitle language.
4. Press RETURN (↵) to exit the On-Screen display.

### Changing subtitle code page

If the subtitle is not displayed properly, you can change the subtitle code page to view the subtitle file properly.

1. During playback, press INFO/DISPLAY (i) to display the On-Screen display.
2. Use  $\wedge/V$  to select the [Code Page] option.
3. Use  $\langle / \rangle$  to select desired code option.
4. Press RETURN (↵) to exit the On-Screen display.

### Movie file requirement

Movie file compatibility with this unit is limited as follows :

- Available resolution: within 720 x 576 (W x H) pixels.
- The file name of the DivX subtitle should be entered within 45 characters.
- If there is impossible code to express in the DivX file, it may be displayed as “ \_ ” mark on the display.
- Frame rate : less than 30 fps.
- If the video and audio structure of recorded files is not interleaved, either video or audio is outputted.
- Playable movie file : “.avi”, “.mpg”, “.mpeg”, “.divx”
- Playable Subtitle format : SubRip (\*.srt/ \*.txt), SAMI (\*.smi), SubStation Alpha (\*.ssa/ \*.txt), MicroDVD (\*.sub/ \*.txt), SubViewer 2.0 (\*.sub/ \*.txt), Vobsub (\*.sub)
- Playable Codec format : “DIVX3.xx”, “DIVX4. xx”, “DIVX5.xx”, “MP4V3”, “3IVX”.
- Playable Audio format : “AC3”, “DTS”, “PCM”, “MP3”, “WMA”.
- Sampling frequency : within 32 to 48 kHz (MP3), within 32 to 48 kHz (WMA)
- Bit rate : within 32 to 320 kbps (MP3), 40 to 192 kbps (WMA)
- For Discs formatted in Live file system, you can not it on this unit.
- If the name of movie file is different from that of the subtitle file, during playback of a DivX file, subtitle may not be display.
- If you play a DivX file differ from DivXspec, it may not operate normally.

### Viewing a photo

You can view photo files contained in a USB device.

1. Select [Photo] using </> on the [USB] menu.  
The [PHOTO] menu appears.

[PHOTO] menu



Options	Buttons	Description
UP FOLDER	Select a desired option using $\wedge/V/$ </>.	Returning to the upper folder.
↓/↑		Moving to the previous or next page.
▶ Slide Show	▶ (PLAY)	Viewing a slide show.
◀▶▶ Move	$\wedge/V/$ </>	Moving to another file or content.
⊙ Select	ENTER (⊙)	Viewing a particular file.
↶ Close	RETURN (↶)	Returning to the [USB] menu.

2. Select a file using  $\wedge/V/$  </>, and press ▶ (PLAY) or ENTER (⊙) to play the file.

Options	Buttons	Description
▶ Slide Show	▶ (PLAY)	Viewing a slide show.
⊙ Select	ENTER (⊙)	Viewing a particular file.

### To stop a slide show

Press ■ (STOP) during slide show.

### To pause a slide show

Press ■■ (PAUSE) during slide show.  
Press ► (PLAY) or ■■ (PAUSE) to re-start the slide show.

### To skip to the next/previous photo

While viewing a photo in full screen, press < or > to go to the previous or next photo.

### Options while viewing a photo

You can use various options while viewing a photo in full screen.

1. While viewing a photo in full screen, press INFO/DISPLAY (□) to display the option menu.
2. Select an option using ^/v/</>.

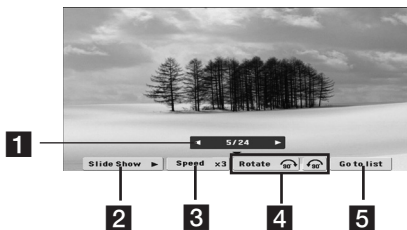

- 1 Current photo/Total number of photos**  
– Use </> to view previous/next photo.
- 2 Slide Show** – Press ENTER (⊙) to start or pause slide show.
- 3 Speed** – Use ENTER (⊙) to select a delay time between photos in a slide show.
- 4 Rotate** – Press ENTER (⊙) to rotate the photo clockwise/counterclockwise.
- 5 Go to list**– Press ENTER (⊙) to return [Photo] menu.

3. Press RETURN (↵) or INFO/DISPLAY (□) to exit the option menu.

### Photo file requirement

Photo file compatibility with this unit is limited as follows :

- Max pixel in width : 2 760 x 2 048 pixel
- Maximum files : Under 999
- Some files may not operate due to a different recording format or the condition of file.
- File extensions:“.jpg”
- CD-ROM file format : ISO 9660/ JOLIET

### Dimmer

Press DIMMER once. The display window will be darkened by half. To cancel it, press DIMMER again.

### Screen Saver

The screen saver appears when you leave the unit in Stop mode for about five minutes.

## Using the Sleep Timer

You can set the unit to turn off automatically at a specified time.

Press SLEEP repeatedly.

The indicator changes cyclically in the display window as follows.

SLEEP 180 → 150 → 120 → 90 → 80 → 70  
→ 60 → 50 → 40 → 30 → 20 → 10 →  
Off (No display)

To check the remaining time, press SLEEP. The remaining time appears in the display window.

To cancel the sleep function, press SLEEP repeatedly until "SLEEP 10" appears, and then press SLEEP once again while "SLEEP 10" is displayed.

4

Operation

### NOTE

When the sleep timer is activated, the display window dims.

## Using microphone

1. Connect a microphone (∅ 6.3 mm) to MIC jack.

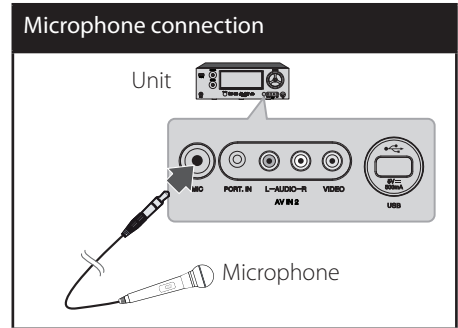

"🎤" is displayed in the display window.

2. Play the music you want.
3. Sing along with the accompaniment.
4. Adjust the microphone volume by pressing MIC VOL (-/+).
5. Adjust the echo volume by pressing ECHO VOL (-/+).

### NOTE

- When not using the microphone, set the microphone volume to minimum or turn off the microphone and remove the microphone from the MIC jack.
- If the microphone is set too near the speaker, a howling sound may be produced. In this case, move the microphone away from the speaker or decrease the sound level by using the MIC VOL(+/-) button.
- The microphone function is not operated in the digital (COAXIAL 1, COAXIAL 2, OPTICAL 1, OPTICAL 2 or HDMI IN) mode.

# 5

## Maintenance

### Handling the Unit

#### When shipping the unit

Please save the original shipping carton and packing materials. If you need to ship the unit, for maximum protection, re-pack the unit as it was originally packed at the factory.

#### Keeping the exterior surfaces clean

- Do not use volatile liquids such as insecticide spray near the unit.
- Wiping with strong pressure may damage the surface.
- Do not leave rubber or plastic products in contact with the unit for a long period of time.

#### Cleaning the unit

To clean the player, use a soft, dry cloth. If the surfaces are extremely dirty, use a soft cloth lightly moistened with a mild detergent solution. Do not use strong solvents such as alcohol, benzine, or thinner, as these might damage the surface of the unit.

#### Maintaining the Unit

The unit is a high-tech, precision device. If the optical pick-up lens and disc drive parts are dirty or worn, the picture quality could be diminished. For details, please contact your nearest authorized service centre.

# 6

## Troubleshooting

### Troubleshooting

PROBLEM	CAUSE	CORRECTION
No power.	<ul style="list-style-type: none"> <li>The power cord is disconnected.</li> </ul>	<ul style="list-style-type: none"> <li>Plug the power cord into the wall outlet securely.</li> </ul>
No sound.	<ul style="list-style-type: none"> <li>The speaker wires are disconnected.</li> <li>The MASTER VOLUME is adjusted too low.</li> <li>The MUTE button is pressed to ON.</li> <li>The selected decoding mode is not matched to the input signal format.</li> <li>Incorrect selection of input source.</li> <li>Incorrect connections between the components.</li> </ul>	<ul style="list-style-type: none"> <li>Check the speaker connections.</li> <li>Adjust the MASTER VOLUME.</li> <li>Press the MUTE button to cancel the muting effect.</li> <li>Select the available decoding mode.</li> <li>Select the desired input source correctly.</li> <li>Make connections correctly.</li> </ul>
Radio stations can't be tuned in properly.	<ul style="list-style-type: none"> <li>The antenna is positioned or connected poorly.</li> <li>The signal strength of the radio station is too weak.</li> <li>No stations have been preset or preset stations have been cleared (when tuning by scanning preset channels).</li> </ul>	<ul style="list-style-type: none"> <li>Check the antenna connection and adjust its position.</li> <li>Tune to the station manually.</li> <li>Preset some radio stations, see page 28 for details.</li> </ul>

<p>Preset stations cannot be received.</p>	<ul style="list-style-type: none"> <li>• An incorrect station frequency has been memorized.</li> <li>• The memorized stations are cleared.</li> </ul>	<ul style="list-style-type: none"> <li>• Memorize the correct station frequency.</li> <li>• Memorize the stations again.</li> </ul>
<p>Poor FM reception.</p>	<ul style="list-style-type: none"> <li>• No antenna is connected.</li> <li>• The antenna is not positioned for the best reception.</li> </ul>	<ul style="list-style-type: none"> <li>• Connect the antenna.</li> <li>• Change the position of the antenna.</li> </ul>
<p>The remote control doesn't work well / at all.</p>	<ul style="list-style-type: none"> <li>• The remote control is not pointed directly at the unit.</li> <li>• The remote control is too far from the unit.</li> <li>• There is an obstacle in the path between the remote control and the unit.</li> <li>• The battery in the remote control are flat.</li> </ul>	<ul style="list-style-type: none"> <li>• Point the remote directly at the unit.</li> <li>• Use the remote within 23 feet (7m) of the unit.</li> <li>• Remove the obstacle.</li> <li>• Replace the batteries with new ones.</li> </ul>

# 7 Appendix

## Trademarks and Licenses



HDMI, the HDMI logo and High-Definition Multimedia Interface are trademarks or registered trademarks of HDMI licensing LLC.



DivX®, DivX Certified® and associated logos are registered trademarks of DivX, Inc. and are used under license.”



Manufactured under license from Dolby Laboratories. Dolby and the double-D symbol are trademarks of Dolby Laboratories.



Manufactured under licence under U.S. Patent #'s: 5,451,942; 5,956,674; 5,974,380; 5,978,762; 6,487,535 & other U.S. and worldwide patents issued & pending. DTS and the Symbol are registered trademarks & DTS Digital Surround and the DTS logos are trademarks of DTS, Inc. Product includes software. © DTS, Inc. All Rights Reserved.

---



# Specifications

## General

- Power requirements: Refer to main label.
- Power consumption: Refer to main label.
- Dimensions (W x H x D): 430 x 150 x 312 mm
- Net Weight (Approx.): 4.1 kg
- Operating temperature:  
41 °F to 95 °F (5 °C to 35 °C)
- Operating humidity: 5 % to 90 %
- Bus Power supply (USB): DC 5 V  $\overline{=}$  500 mA

## Inputs/ Outputs

- AUDIO OUT:  
2.0 Vrms (1 kHz, 0 dB), 600  $\Omega$ ,  
RCA jack (L, R) x 1
- VIDEO OUT:  
1.0 V (p-p), 75  $\Omega$ , sync negative, RCA jack x 1
- HDMI IN/OUT (video/audio):  
19 pin (HDMI standard, Type A), HDMI  
version 1.2A
- OPTICAL IN 1/2: 3 V (p-p), Optical jack x 2
- COAXIAL IN 1/2: 3 V (p-p), Coaxial jack x 2
- ANALOG AUDIO IN (AV1/AV2):  
2.0 Vrms (1 kHz, 0 dB), 600  $\Omega$ ,  
RCA jack (L, R) x 2
- ANALOG VIDEO IN (AV1/AV2):  
1.0 V (p-p), 75  $\Omega$ , sync negative, RCA jack x 2
- PORT. IN: 0.5 Vrms ( $\varnothing$  3.5 mm stereo jack)

## Tuner

- FM Tuning Range:  
87.50 to 108.00 MHz or 87.5 to 108.0 MHz
- AM Tuning Range:  
522 to 1 620 kHz or 530 to 1 720 kHz

## Amplifier

- Stereo mode: 100 W + 100 W (4  $\Omega$  at 1 kHz)
- Surround mode:  
Front: 100 W + 100 W (4  $\Omega$  at 1 kHz)  
Center: 100 W (4  $\Omega$  at 1 kHz)  
Rear: 100 W + 100 W (4  $\Omega$  at 1 kHz)  
Subwoofer: 150 W + 150 W (3  $\Omega$  at 1 kHz)

**Speakers**

## • Front speaker

Type: 2 Way 2 speaker

Impedance: 4  $\Omega$

Rated Input Power: 100 W

Max. Input power: 200 W

Net Dimensions (W x H x D):

230 x 905 x 335 mm

Net Weight: 13.8 kg

## • Rear speaker

Type: 2 Way 2 speaker

Impedance: 4  $\Omega$

Rated Input Power: 100 W

Max. Input power: 200 W

Net Dimensions (W x H x D):

175 x 453 x 249 mm

Net Weight: 3.4 kg

## • Center speaker

Type: 2 Way 3 speaker

Impedance: 4  $\Omega$

Rated Input Power: 100 W

Max. Input power: 200 W

Net Dimensions (W x H x D):

515 x 175 x 254 mm

Net Weight: 5.0 kg

## • Subwoofer

Type: 1 Way 1 speaker

Impedance: 3  $\Omega$

Rated Input Power: 150 W

Max. Input power: 300 W

Net Dimensions (W x H x D):

275 x 377 x 319 mm

Net Weight: 6.8 kg

**Designs and specifications are subject to change without prior notice.**



